

KD-40-160/4

K-40-160/4

KM-40-160/4

P101522

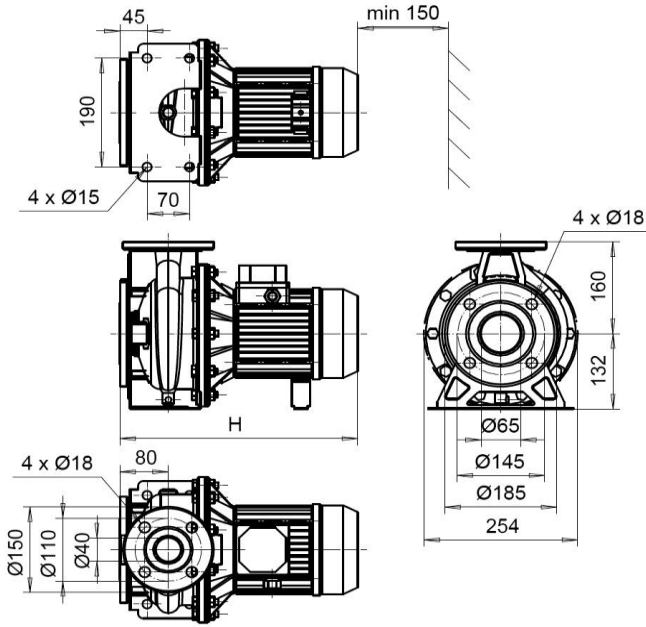

ZH05	P_{2N}	I_N 400V	m	H
	[kW]	[A]	[kg]	[mm]
	0,55	1,6	33	393

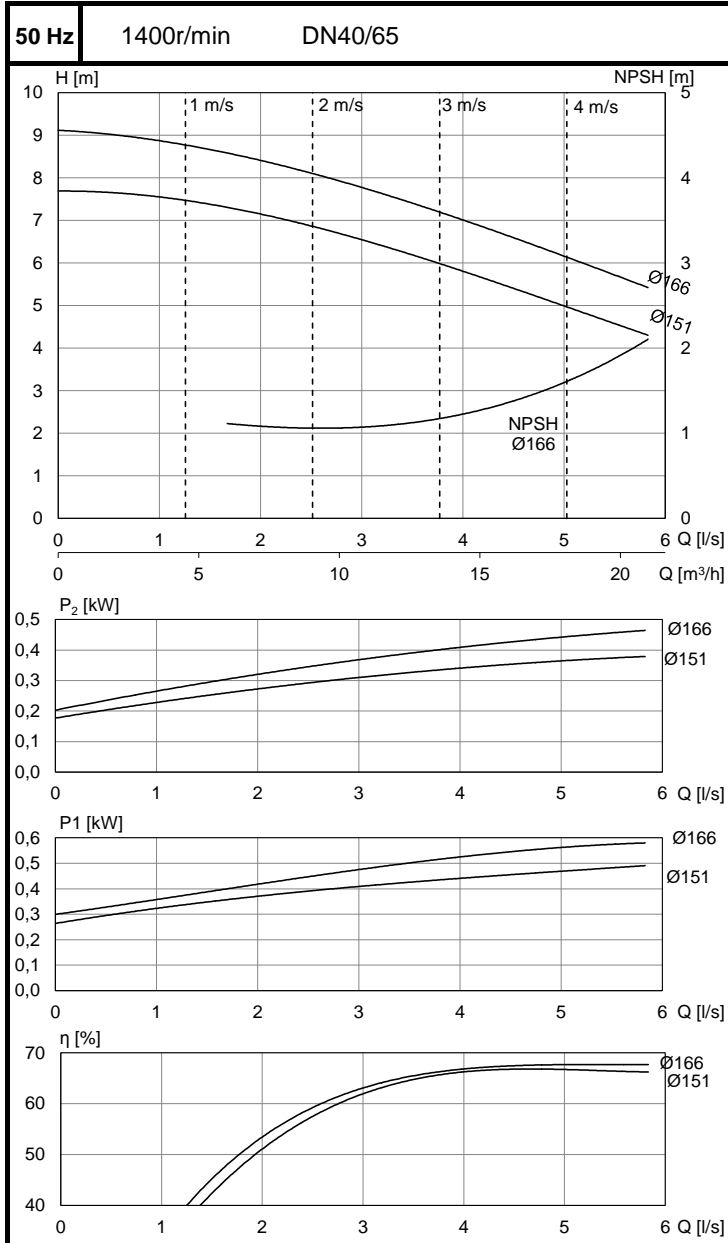

60 Hz is not available